

Reactive Power Control of an Alternator with Static Excitation System Connected to a Network

Dr. Dhiya Ali Al-Nimma
Assist. Prof.
Mosul Unoversity

Dr. Majid Salim Matti
lecturer
Mosul University

Abstract

In recent years, the scale of power systems has been expanding, and with that expansion smooth power operation is becoming increasingly important. One of the solutions is to realize a practical high speed, highly reliable exciter system that is suitable for stable operation of a power system.

In this work, a model of a static excitation system of an alternator connected to a network via a transformer have been built using MATLAB-SIMULINK PSB. The parameters of the machine has been obtained from Mosul dam power station taking into account saturation effects. A PI controller is used to control the output reactive power of the synchronous generator for both pure DC excitation and static excitation systems. A method based on step response has been proposed and verified for tuning the parameters of the controller. In order to validate the simulated results of the system with AVR, the results have been compared with practical results of Mosul dam and a good agreement has been realized. However, in large generating units, undesirable oscillations in the active power and speed result as a side effect of the AVR control or due to outside disturbances.

KEY WORDS: Static Excitation, Reactive Power Control.

التحكم بالقدرة المتفاعلة لمناوب ذي إثارة مستقرة مرتبط بشبكة

الدكتور ماجد سالم متي

مدرس - جامعة الموصل

الدكتور ضياء علي النعمة

أستاذ مساعد - جامعة الموصل

الخلاصة

ما انفكت أنظمة القدرة في العالم في توسع مستمر وتزداد معه أهمية الحصول على قدرة تشغيلية سلسة. إن أحد الحلول الممكنة هو التوصل إلى نظام إثارة ملائم يمتاز بثوثوقية عالية إضافة إلى سرعة استجابة عالية لتحقيق تشغيل مستقر لنظام القدرة.

تم في هذا البحث نمذجة نظام الإثارة لمناوب مرتبط بشبكة عبر محولة وذلك باستخدام برمجيات (MATLAB - PSB) - SIMULINK. تم استخدام ثوابت المناوب لمحطة التوليد في سد الموصل أخذين بالاعتبار تأثير حالة التشبع للماكنة. استخدم متحكم تناسبى - تكاملى (PI) للتحكم بالقدرة المتفاعلة للمولد التزامنى باستخدام إثارة مباشرة (DC) نقيه إضافة إلى نظام إثارة مستقر (Static Excitation). وقد اقترحت طريقة مبنية على استجابة الخطوة وتم التحقق منها في تحديد ثوابت المتحكم. ولأجل التأكد من صحة النموذج المستخدم للنظام الذي يعمل بمنظم الفولتية الذاتى (AVR)، فقد قورنت نتائج التمثيل مع نتائج عملية لسد الموصل و تحقق توافق كبير بين النتائج العملية والحاسوبية. تم الحصول على استجابة جيدة للقدرة المتفاعلة للمولد إلا أنه ظهر بعض التذبذب في القدرة الفاعلة كتأثير جانبي إما بفعل منظم الفولتية الذاتى (AVR) أو بتأثيرات خارجية.

Introduction

For many years the exciters used in alternators were DC generators driven by either the steam turbine on the same shaft of the generator or by an induction motor. In the last three decades, static excitation systems are introduced. Old systems are being replaced by new system for many advantages (such as quick response, online maintenance and high field current). The static systems consist of some form of controlled rectifiers or choppers supplied by the ac bus of the alternator or from an auxiliary bus. The voltage regulator controls the output of the exciter so that the generated voltage and reactive power can be controlled. The excitation system must contribute to the effective voltage control and therefore enhance the system stability. It must be able to respond quickly to a disturbance, thereby enhancing the transient stability as well as the small signal stability. In most modern systems the automatic voltage regulator (AVR) is a controller that senses the generator output voltage and the current or reactive power then it initiates corrective action by changing the exciter control to the desired value. The excitation system controls the generated EMF of the generator and therefore controls not only the output voltage but the reactive power as well.

The response of the AVR is of great interest in studying stability. It is difficult to make rapid changes in field current, because of the high inductance in the generator field winding. This introduces a considerable lag in the control function and is one of the major obstacles to be overcome in designing a regulating system. The AVR must keep track of the generator output reactive power all the time and under any working load conditions in order to keep the voltage within pre-established limits. Based on this, it can be said that the AVR also controls power factor of the machine once these variables are related to the generator excitation level.

The AVR quality influences the voltage level during steady state operation and also reduces the voltage oscillations during transient periods, affecting the overall system stability.

Most researchers on modeling and simulation of generating systems found in the literature [1-5] did not use detailed models for the generating units with their detailed excitation system. Moreover researchers who implemented PI and PID controller for AVR in their models ignored a detailed procedure for determining controller parameters.

Figure 1 shows the block diagram of a typical excitation system of a large synchronous generator [6].

In this work, which is part of a Ph. D thesis [7], a static excitation system of an alternator connected to a network via a transformer have been modeled and simulated using MATLAB-SIMULINK PSB.

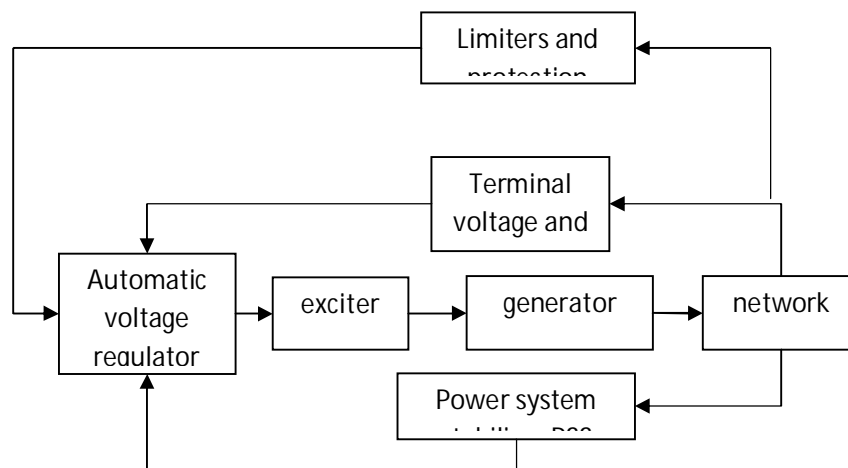

Figure 1 Block diagram of synchronous generator and excitation system with AVR and PSS.

Types of excitation systems

Based on excitation power source, the excitation systems have taken many forms over the years, namely, dynamic excitation and static excitation systems. In a dynamic excitation system the most parts are connected to the rotor, so that the carbonic brushes can be removed. It is sometimes called brushless excitation systems. This type uses some sort of rotating machines; thus their responses are poor besides the need for regular maintenance. In static excitation systems, on the other hand, all components are static or stationary. Static rectifier, supply the excitation current directly to the field of the synchronous generator through slip rings. The supply of the power to the rectifiers is from the main generator or via the station auxiliary bus through a step down transformer.

Automatic Voltage Regulator AVR is the brain of the excitation system. Its responsibility is to control current such that, building generator voltage at starting, regulating voltage and output reactive power after connecting the unit to a network. The AVR must have high gain to keep the operational variations within prescribed limits, good open circuit response, minimum dead band and high speed of response [8].

The AVRs work on the principle of error detection. The alternator three phase output voltage obtained through a potential transformer is compared with a reference value. When the alternator is connected to a network, and in order to control the output reactive power, the signal delivered and compared are the output voltage and output current. From these two variables the output reactive power is determined and compared with a reference signal in order to determine the error used to suggest the increment or decrement of field voltage.

Power Converter

Mostly, the power converter is a thyristor three-phase bridge. The power converter may be controlled by manual channel or by AVR. All excitation power is normally derived either from the synchronous machine terminals or from auxiliary source through an excitation transformer. The voltage regulator controls the thyristor converter through a pulse-triggering unit. The power rectifying bridges are full converter, 6 pulse, inverting type and can provide currents up to 10000 A DC and voltage up to 1400 V DC. Each rectifier bridge includes protection circuitry such as snubbers and fuses. Depending on the rating of the system, the rectifier may comprise a single stack or multiple units in parallel for higher power levels. In most redundant applications, each bridge is rated to the full excitation requirement for the particular generator; however, during normal operation all bridges are put to work sharing the load. The benefits are that by sharing load the life expectancy of the SCR's is extended while at the same time providing a hot backup.

System Description

The basic function of any excitation system is to provide direct current to the synchronous machine field winding. The excitation system controls and protects essential functions of the power system for satisfactory operation and performance. The control functions include the control of the generator voltage, reactive power flow and the enhancement of system stability. The protective functions ensure that the capability limits of the synchronous machine, excitation system and other equipment are not exceeded.

The presented system used in this study consists of an alternator connected to an infinite bus via a transformer. Static excitation system is used for the generator. The Simulink model for the system under study is shown in Figure 2. The whole system has been modeled using

MATLAB SIMULINK and power system blockset (PSB), in which the machine model that can be operated as a motor or as a generator, has been represented by the sixth order state space model [9].

The parameters of the most important block of the model, i.e. the synchronous machine, are presented in appendix A. The static excitation system is a three phase controlled bridge converter. Using PSB the machine block accepts the excitation voltage V_f as an input signal. If the signal is abstracted from the R_f-L_f load of the bridge, no loading effects of the machine will be imposed on the thyristor bridge and thus the simulation results would not be correct. To overcome this problem and to model the whole system as one network, the machine block has been modified as shown in Figure 2.

In order to validate the simulation results, parameters of the machine and the system parameters of one generating unit in the Mosul dam power station have been adopted and used. The parameters are tabulated in appendix A. Company's test results of the generator are used for comparison.

AVR Control

In order to control the output reactive power, the field voltage must be changed in the desired way. In this paper, methods for controlling the output reactive power are described. using conventional PI controller applied for pure DC supply as well as for static excitation system

PI Controller Design with Pure DC Excitation

The PI and PID controllers are widely used in industrial control systems because of the reduced number of parameters to be tuned. The most popular design technique is Ziegler_Nichols method [10], in which its parameters can be obtained from the step response of the system. This method is suitable for some types of step responses specially with time delay, but if the step response of the system has no time delay, this method fails. The step response has several values that are of importance in obtaining an approximate transfer function for the system.

The relation between field voltage and output reactive power can be approximated by the first order transfer function [10].

$$T.F = \frac{K}{\tau s + 1} \quad (1)$$

Where, τ is the time constant of the system, K is the gain.

To obtain approximate transfer function, firstly, we find Y_{ss1} and Y_{ss2} which are the steady-state values for the output before and after step change in the input. Secondly, we determine the area A_o in order to calculate the approximate time constant of the system τ as shown in Figure 3 where,

$$\tau = A_o / (Y_{ss2} - Y_{ss1}) \quad (2)$$

The simulink model used to determine A_o and τ is given in Figure 4.

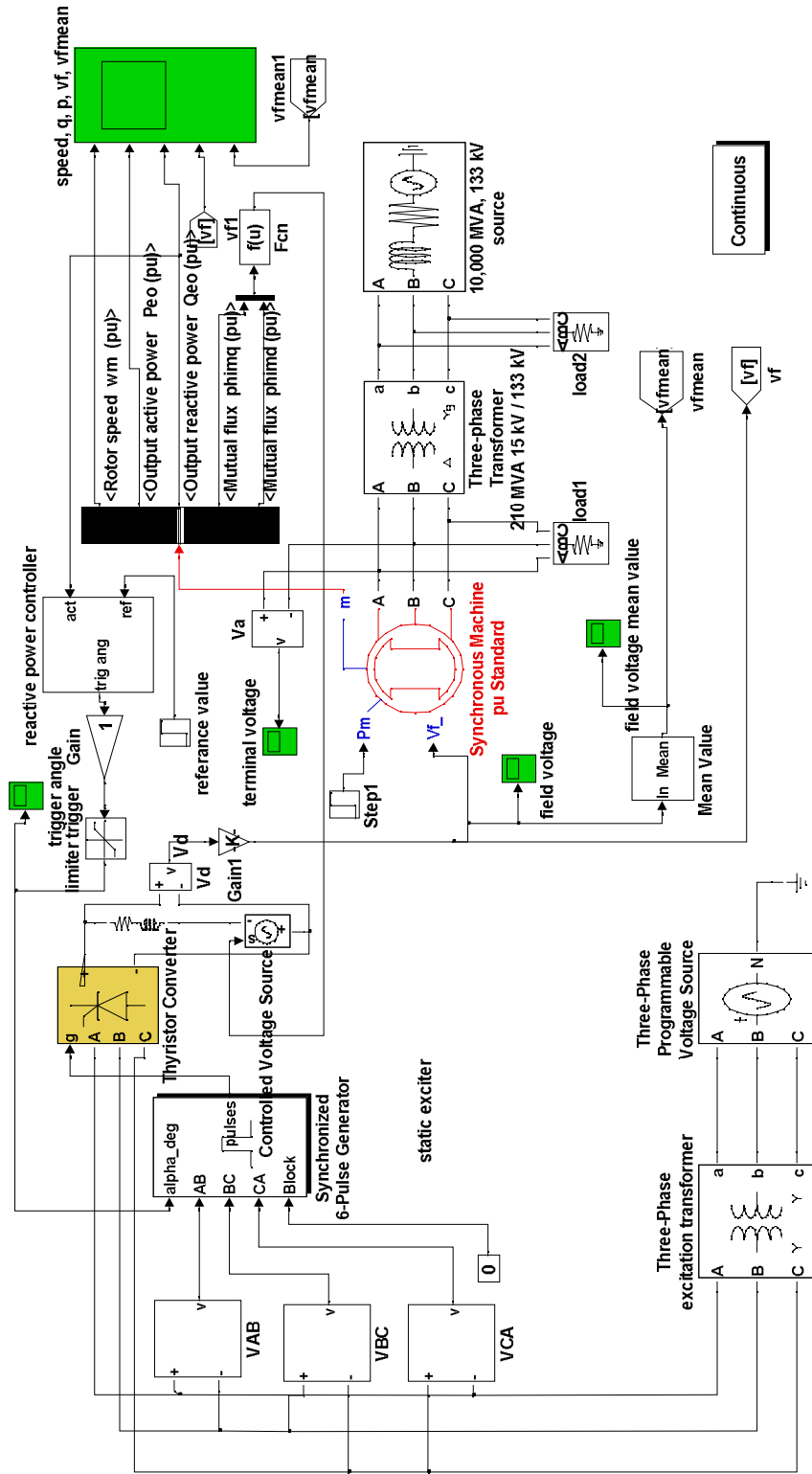

Figure 2 SIMULINK model of the system under study.

The time constant τ of the approximate transfer function of the first order so obtained for the system was 2.75 sec (although it may be changed due to non linearity of the synchronous machine). Thirdly, we find the parameters of PI controller, which is sufficient for the first order system as explained below:

Figure 5 shows the system to be controlled and the PI controller with the parameters K_p and K_i .

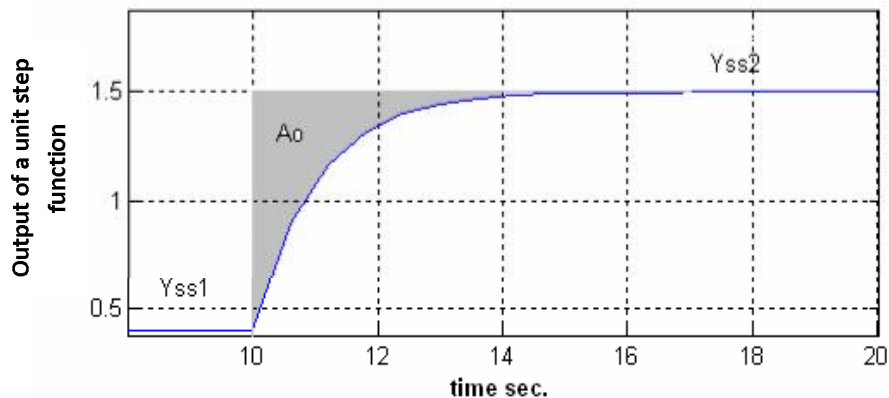

Figure 3 A_o , Y_{ss1} and Y_{ss2} in a step response

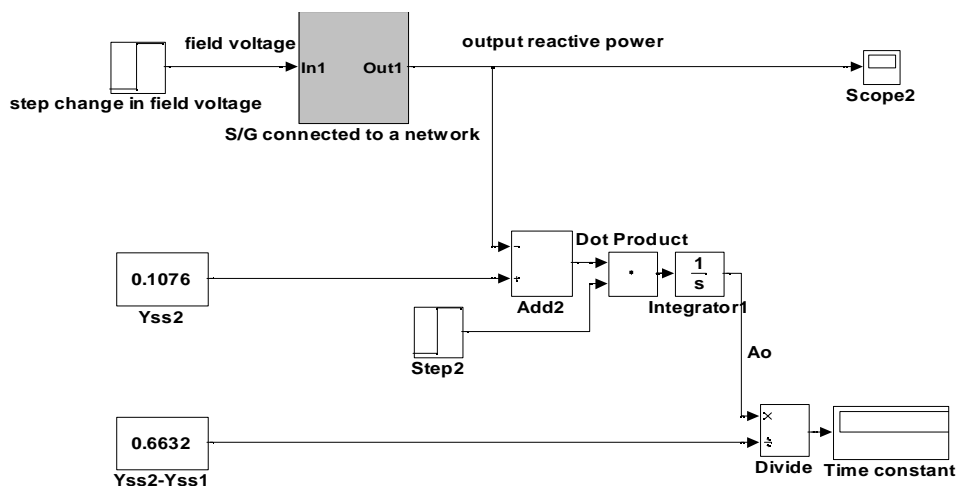

Figure 4 SIMULINK model used to determine approximate time constant.

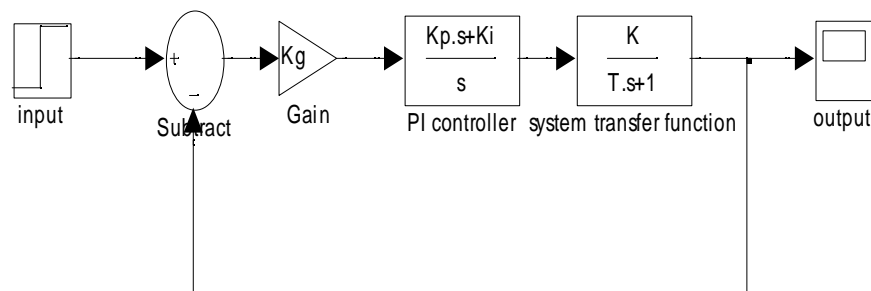

Figure 5 System controlled by PI controller.

From the above system it can be seen that the system has a pole at $s=-1/\tau$ and the controller has a zero at $s=-K_i/K_p$ then getting a system with transfer function K/s if we choose the value $K_i/K_p=1/\tau$ which has a response as a unit step function without overshoot, and by changing the overall gain $K_g * K$ to get optimal value of response by decreasing the rising time. If we assume that $K_i=1$ then we can say that if $K_p=\tau$ we can get a response without over shoot. If $K_p < \tau$ we get over damped response and if $K_p > \tau$ we get an under damped response. After that and in order to prove the assumption we use the SISO (Single Input Single Output) MATLAB tools and GUI (graphics user interface). Figure 6a shows the SIMULINK model to compare the step response of the system without controller and with PI controller. The parameters of the PI controller thus obtained were $K_p=2.75$ and $K_i=1$. In order to decrease rising time, the over all gain must be increased.

Figure 6b shows a comparison between step responses of the close loop system without PI controller and with PI controller with different gains (see the rising time).

Figure 7 shows a comparison between step responses for the system with PI controller and (fixed gain and $K_i=1$) but variant K_p ($K_p=\tau$, $K_p < \tau$ and $K_p > \tau$).

It must be noted that the time constant τ of the studied system varied from 2.75 sec to 3.3 sec depending on the range of the reference change and the parameters of the transformer. It is found that the parameters of the PI controller can be fixed with acceptable response at minimum $\tau=2.75$.

In order to control the output reactive power of the alternator connected to a network using the suggested PI controller, the model was built using SIMULINK with pure DC excitation as a first step.

Figure 8 shows the result obtained from the model when the set value of reactive power changes from 0.125 pu leading to 0.125 pu lagging at time=20 sec at constant input power 0.25 pu. Figure 9 shows the result obtained from the model when the set value of reactive power changes from 0.125 pu leading to 0.25 pu lagging at time=20 sec. It is found that the settling time is 1.1 sec. in the response of the output reactive power. This is regarded as good, however the

output active power and rotor speed both oscillate with a certain frequency of approximately 0.9 Hz or 6.6 rad/sec. which is regarded as undesirable. The reason of this oscillation is due to the change in load angle δ which affects the output active power. This oscillation can be damped using power system stabilizer.

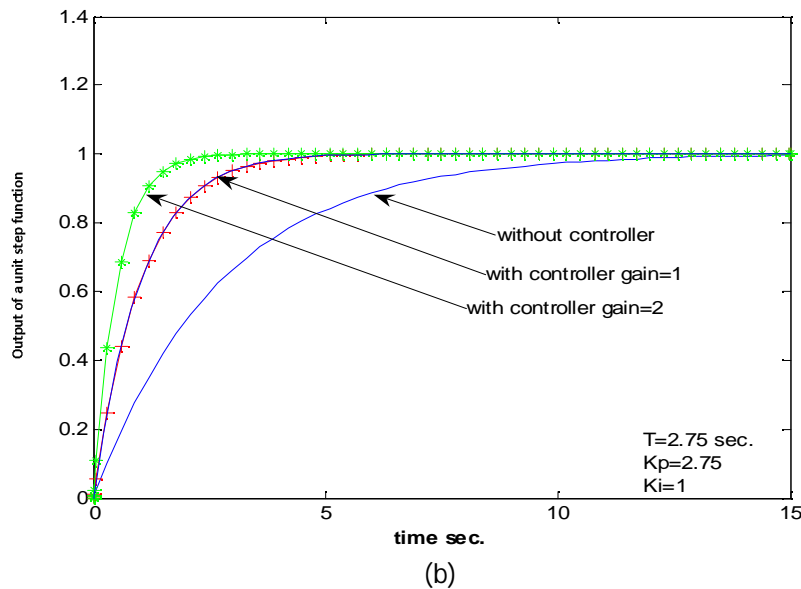
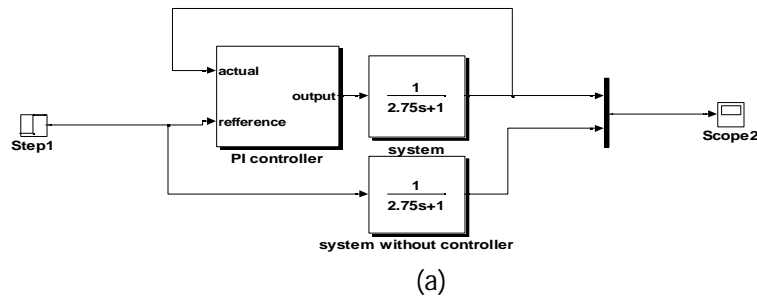

Figure 6 Comparison of step responses of a first order system with PI controller for different gains and without PI controller. (a) SIMULINK model. (b) The step responses

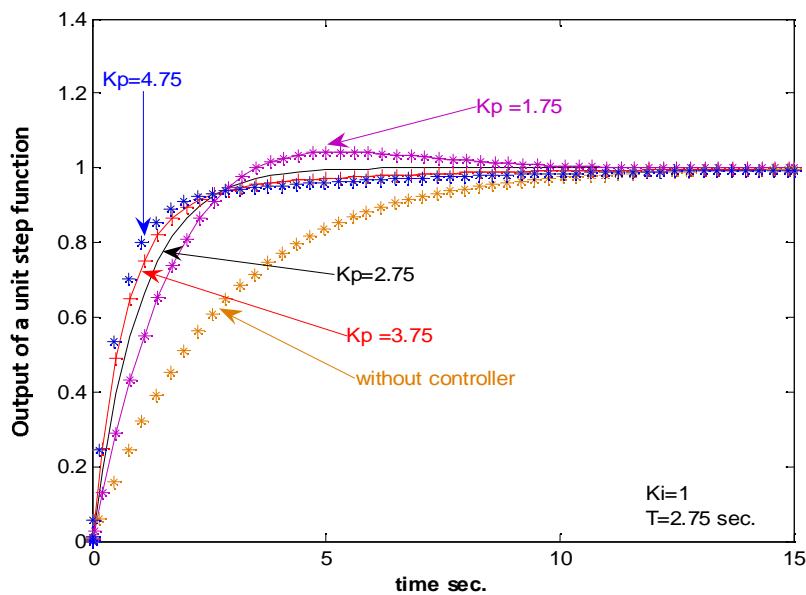

Figure 7 Output step response of a first order system with PI controller for different K_p .

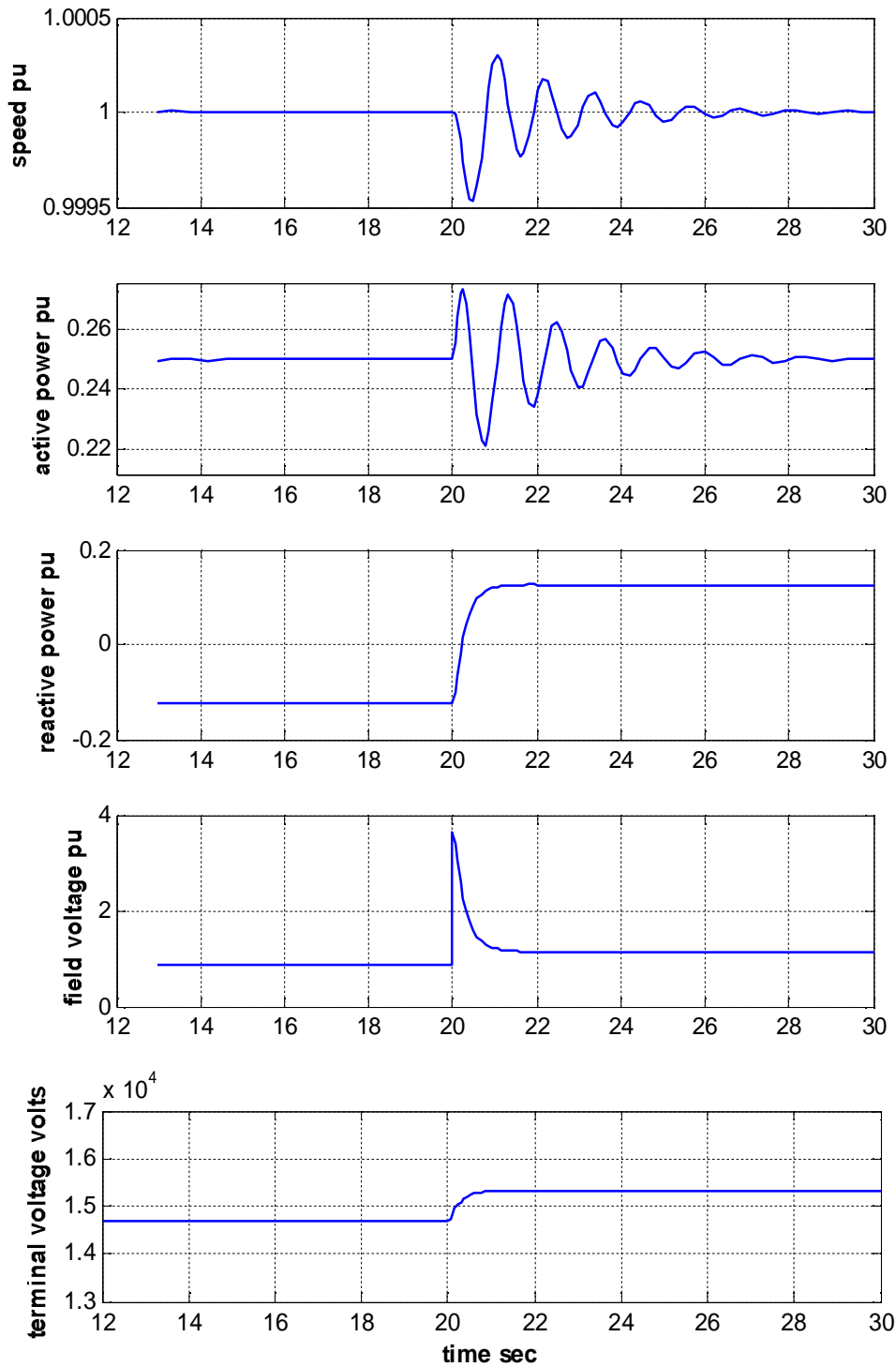

Figure 8 Model response results for a reference step in the reactive power from 0.125 pu lead. to 0.125 pu lag.

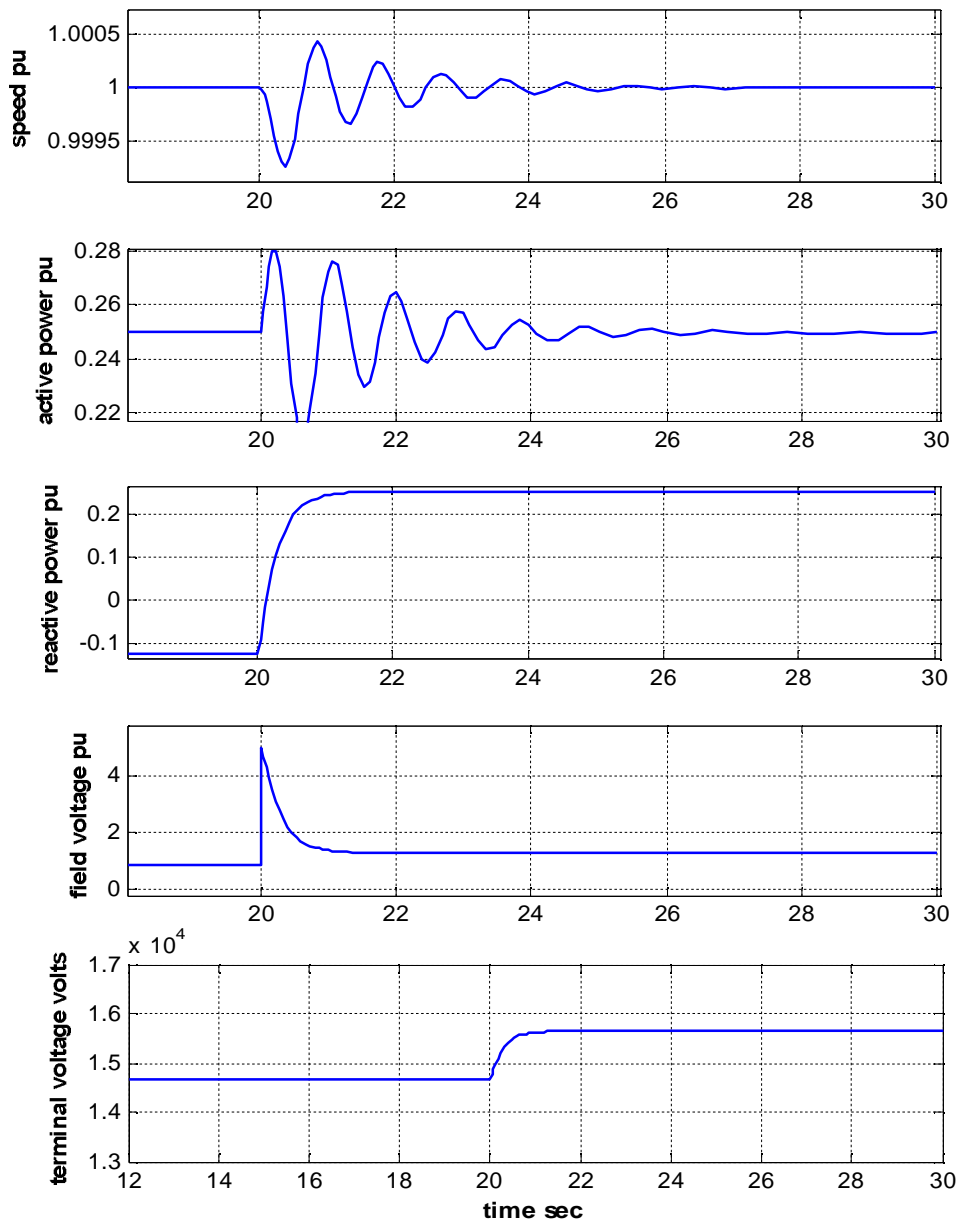

Figure 9 Model response results for a reference step in the reactive power from 0.125 pu lead. to 0.25 pu lag.

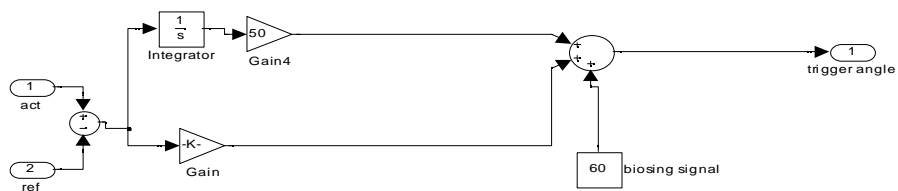

Figure 10 PI controller for static excitation system.

PI Controller Design with Static Excitation

The same steps presented in the previous section can be followed to design a PI controller for reactive power output of the alternator with static excitation system. An additional signal may be added to the controller (biasing signal) in order to improve its response. Figure 10 shows the PI controller modified for static excitation system. A biasing signal of 60 degree is used since it is near the normal operating point of the controller.

Figure 11 shows the results after changing the set value of reactive power from 0.125 pu leading to 0.125 pu lagging. The figures show the unit speed, output active power, output reactive power, field voltage and mean value of field voltage. It is clear from figures that the response in output reactive power has a good rising (0.6 sec) and settling time (1.1 sec), but still there is an oscillation in output active power with frequency of about 7 rad/sec (which may affect the stability of the system), and in unit speed. This oscillation occurs as a result of the disturbance coming from the sudden change in the field voltage.

Figure 12 shows the practical results after changing the set value of reactive power from 0.125 pu (30 MVAR) leading to 0.125 pu (30 MVAR) lagging. Figure shows the output active power, output reactive power, mean value of field voltage. Let us examine the oscillation in output active power and compare it with the results obtained from the simulation (see Figure 11). A comparison between the results shows acceptable (95%) between the SIMULINK model results compared with the practical ones by Toshiba (see Figure 12) [11].

In PSB, the machine block accepts the excitation voltage V_f as an input signal. If the signal is abstracted from an R_f-L_f load of the bridge, no loading effects of the machine will be imposed on the thyristor bridge, and thus the simulation results would not be correct specially when the PI controller decides a value of trigger angle which makes the mean field voltage negative. To overcome this problem and to model the whole system as one network, the machine block has been modified as shown in Fig.2.

Figures 13 and 14 show SIMULINK results when the set value of reactive power changes from 0.125 pu to -0.125 pu. The first figure shows the result without modification while the second shows the results after modification. The figures show that the mean field voltage can be negative after modification which affects the field current to change faster than without modification..

Figure 15 shows the output reactive power controlled by the PI when the time constant is changed for 2.7 and 3.1 seconds..

Table.1 shows a comparison between rising time and settling for PI controller.

Table 1 comparison between responses of fixed parameters PI controller for different time constants

T =2.7 SEC		T =3.1 SEC	
rise time	settling time	rise time	settling time
(s)	(s)	(s)	(s)
0.9	1.2	1.2	1.5

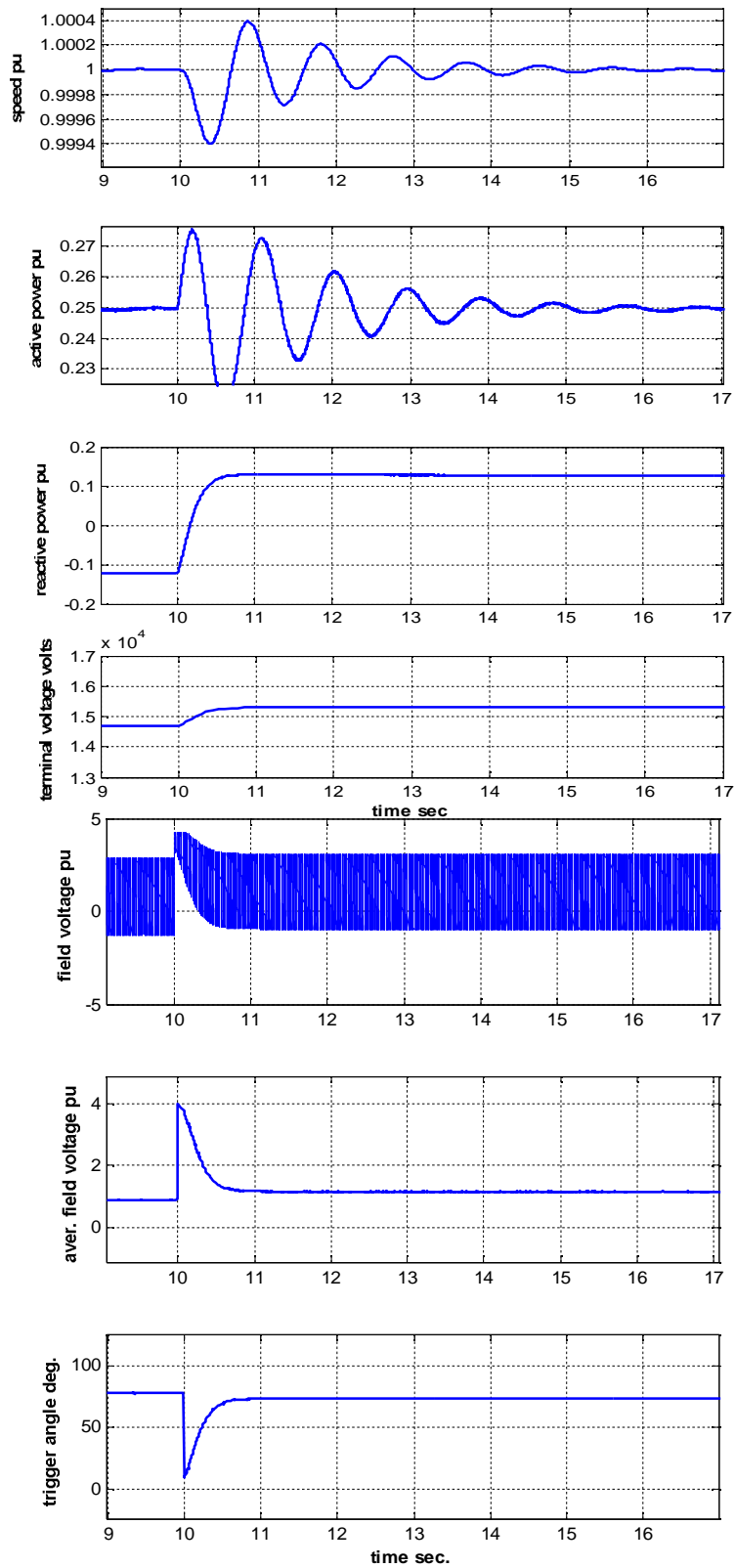

Figure 11 Model results with reference step change in reactive power from 0.125 pu lead. to 0.125 pu laq.

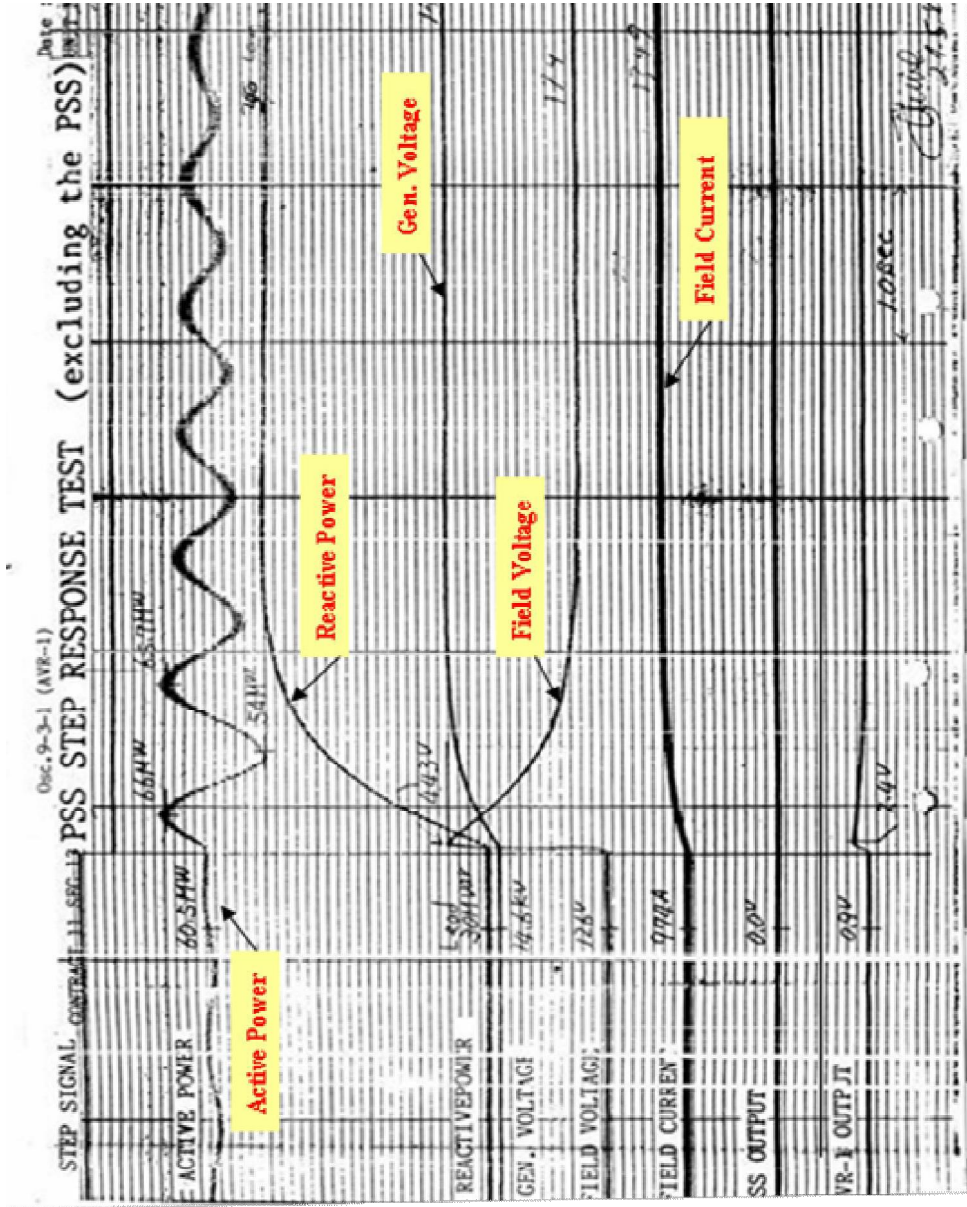

Figure 12 Practical results with reference step change in reactive power from 0.125 pu lead. to 0.125 pu lag. (active power, reactive power, field voltage and terminal voltage).

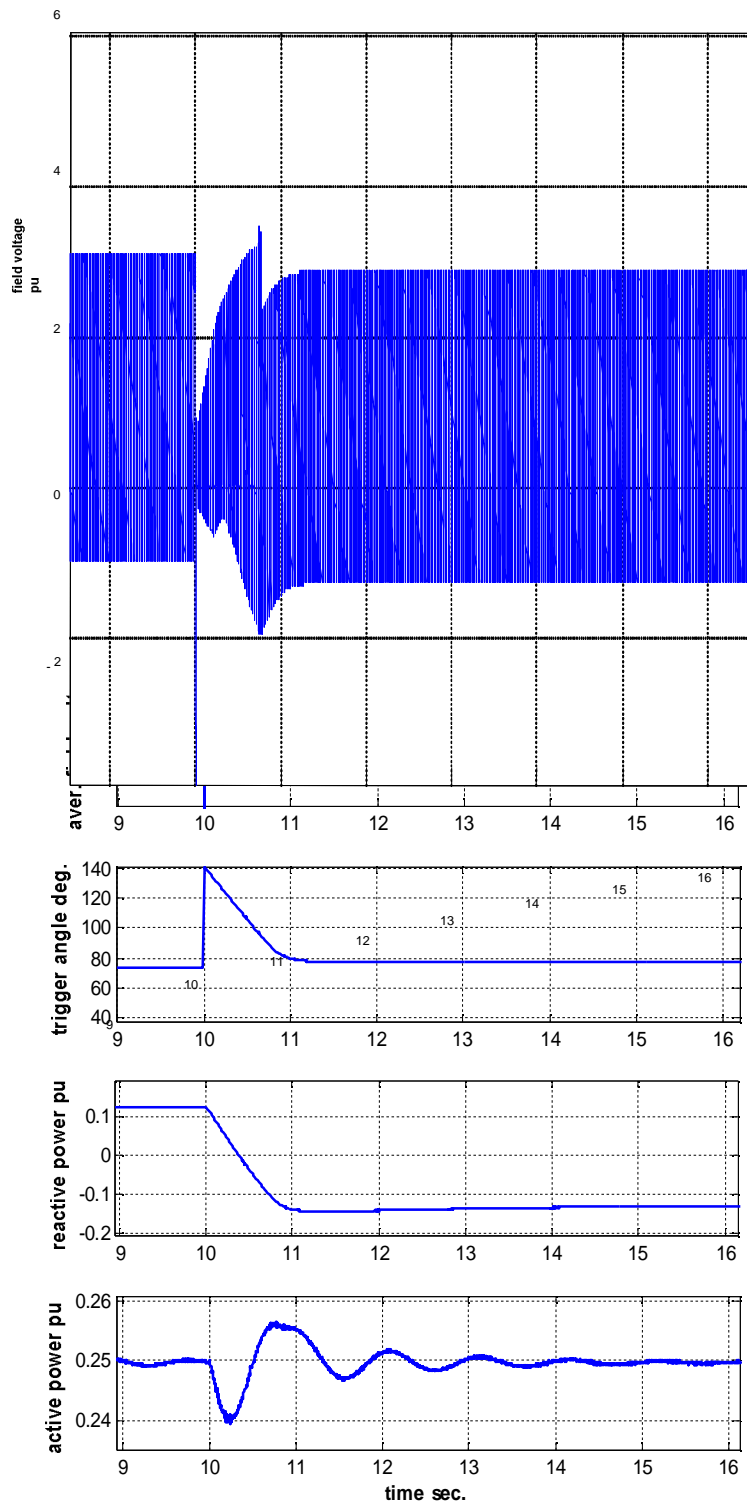

Figure 13 Results obtained when the set value of reactive power changed from 0.125 pu to -0.125 pu without modifications.

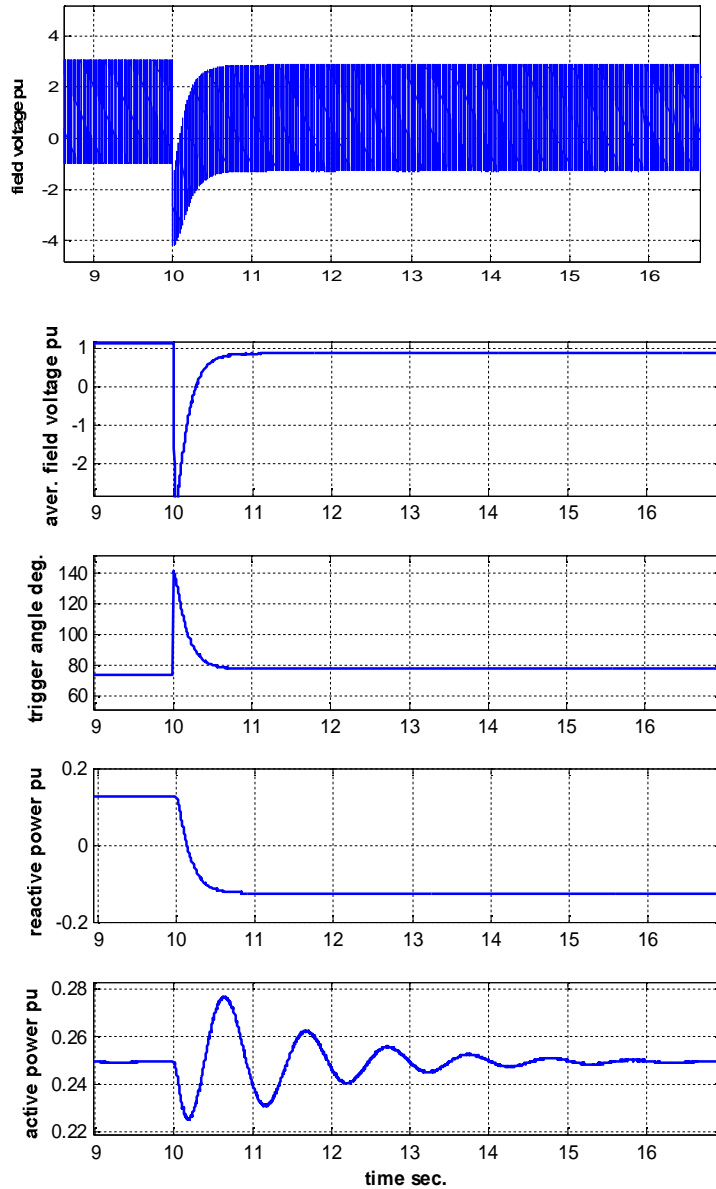

Figure 14 Results obtained when the set value of reactive power changed from 0.125 pu to -0.125 pu with modifications.

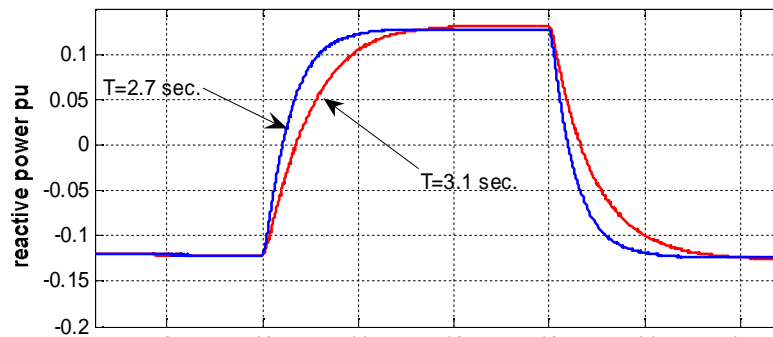

Figure 15 Reactive power for two different time constants using fixed gain PI controller.

Conclusion

A method for tuning the parameters of the controller has been proposed which depends on the step response of the system.

The relation between field voltage and output reactive power can be approximated by first order transfer function for a certain range of field voltage (normal operating conditions).

It is found that the parameters of the PI controller can be obtained mainly from the time constant of the step response. But the time constant of the approximated system is not fixed for all operating conditions; it varies from 2.75 sec to 3.3 sec, due to nonlinearity of synchronous machine and depending on the range of reference change and parameters of the transformer.

It is found that the best ratio of the proportional gain to the integral gain (K_p/K_i) is equal to the time constant of the system. The proposed method has no overshoot for normal operating conditions, but it has small overshoot (5%) for other conditions and a small rising time which can be reduced by increasing the overall gain of the controller.

However, if the gain is increased it will affect the output active power, in such a way as to increase the oscillation time and its maximum overshoot.

The above procedure has been applied to the system with pure DC excitation. The suggested method has been also applied to the generator with static excitation system. The parameter of the PI controller in this case demands an additional biasing signal (30-90) deg. for the trigger angle. A value of 60 deg has been chosen which is very near to the operating point at normal conditions. In this case the PI controller either increase or decrease the trigger angle without exceeding its boundary conditions.

The simulation results obtained are compared with the practical results obtained from Mosul Dam power station. This comparison shows that there is an acceptable agreement between these results (about 95%).

The suggested method of designing the PI reactive power controller is easy to implement with a straightforward design. The direct design method of the controller allows the excitation system designer to choose the parameters of controller and place the poles of the controller at the location where it gives a desired performance. The time constant of the step response of the output reactive power can be varied (2.7 to 3.2 sec), it is found that the adjustment of the PI controller parameters is based on the smallest time constant rather than the maximum time constant.

References

1. A.S. Ibrahim, "Self tuning voltage regulators for a synchronous machine', IEE Proceedings, Vol. 136, Pt. D. No. 5, September 1989.
2. Shigeyuki Funabiki and Atsumi Histsumoto, "Automatic voltage regulator for a synchronous generator with pole-assignment self-tuning regulator" Industrial Electronics, Control and Instrumentation, 1991, Proceedings IEE on industrial conference, page 1807-1811.
3. A. Godhwani and M.J.Basler,"A digital excitation control system for use on brushless excited synchronous generators", IEEE Transaction on energy conversion, Vol. 11, No. 3, Sept. 1996.

4. R. C. Schaefer, "Application of static excitation systems for rotating exciter replacement", IEEE Transaction on energy conversion 1997.
5. Vinko Casic and Zvonko Jurin, "Excitation system with microprocessor based twin-channel voltage regulator for synchronous machines", EPE-PEMC 2002 Dubrovnik & Cavtat.
6. Goran Andersson, "Dynamics and Control of Electric Power System", Swiss Federal Institute of Technology Zurich, 2006.
7. Matti M. S., "Modeling and Simulation of a Static Excitation System of an Alternator Connected to a Network", Ph. D. thesis, Mosul University 2007.
8. Basilio J. C. and Matos S. R., "Design of PI and PID controllers with transient performance specification", IEEE Transaction on education, Vol. 45, No. 4, Nov 2002.
9. The Mathworks, Inc., "MATLAB version 7 help", copyright 2004.
10. A.H.M.S. Ula and Abul R. Hasan, "Design and implementation of a personal computer based automatic voltage regulator for a synchronous machine", IEEE Transaction on energy conversion, Vol. 7, No. 1, March 1992.
11. Toshiba company, "Static Excitation System ", Mosul Dam Documentation. 1990.

Appendix A

The parameters of the machine in MOSUL dam power station and the block parameters of the synchronous machine used in the system model in Fig.2. :

X_D	0.92 P. U.
X_q	0.66 p. u.
X_d''	0.35 p. u.
X_d''''	0.2 p. u.
X_q''	0.27 p. u.
T_{do}	6.7 sec
T_{ds}	2.5 sec
Rated MVA	237 MVA
Rated power	193 MW
Rated Voltage	15000 V
No. of phases	3
Rated current	9123 A
Frequency	50 Hz
Speed	120 rpm
Connection	Star
Rated field voltage	362 V
Rated field current	2220 A
Field current at no load at rated voltage	1149 A
Inertia constant	5 sec

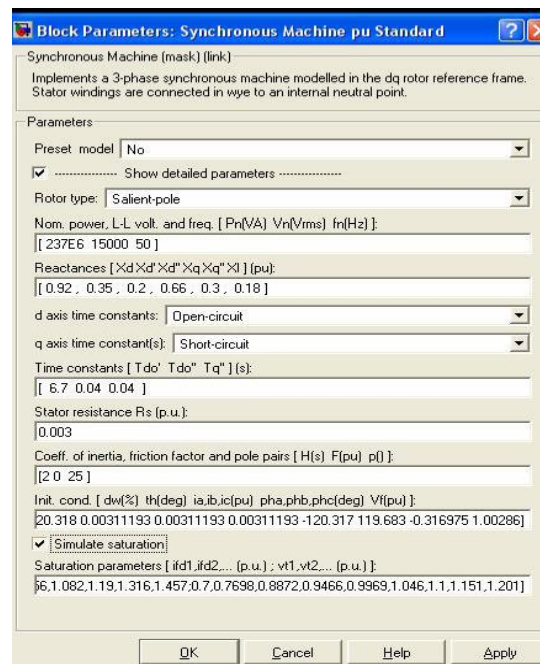

Where:

X_d , X_q are the direct and quadrature axis synchronous reactances respectively, X_d' , X_q' are the direct and quadrature axis transient reactances respectively, X_d'' , X_q'' are the direct and quadrature axis subtransient reactances respectively, T_{do} is direct axis transient open circuit time constant, T_{do}'' is direct axis sub transient open circuit time constant, T_q'' is quadrature axis sub transient short circuit constant..

The work was carried out at the college of Engg. University of Mosul